

## Datasheet DS-TNP-xSR10x

# TapNPass TnP-xSR-10x (NFC, BLE)



**TapNPass Nomad**



**TapNPass Fixed**

The TapNPass monitors and modifies variables in a target system by wirelessly connecting to the target's system bus. The TapNPass supports:

- Physical connections on RS232, RS485 and USB (supporting FTDI232 and CP210x serial transceivers).
- Modbus protocol.
- RF channels: NFC, Bluetooth Smart "Low Energy" (BLE).

Order code	Description
TnP-FSR103	TapNPass Fixed NFC-BLE
TnP-NSR103	TapNPass Nomad NFC-BLE

## Contents

1	Introduction .....	3
2	Summary .....	4
3	Block schematic.....	5
4	Development environment.....	6
5	Features.....	7
5.1	Radio communication channels.....	7
5.1.1	Near Field Communication (NFC) .....	7
5.1.2	Bluetooth Low Energy (BLE) .....	7
5.2	Serial communication channels.....	7
5.2.1	RS232 .....	7
5.2.2	RS485 .....	7
5.2.3	USB-Host.....	7
5.2.4	Communication cables .....	8
5.3	Security features.....	8
5.4	Access control configuration.....	8
5.5	Electrical characteristics .....	8
5.6	Batteries.....	8
5.7	Radio specifications.....	8
5.7.1	Near Field Communication (NFC) .....	8
5.7.2	Bluetooth Low Energy (BLE) .....	9
5.8	Information appliance support .....	9
5.9	Cloud support .....	9
5.10	Operating temperature range .....	9
6	Regulatory compliance .....	10
6.1	Passed Tests .....	10
6.2	RoHS and WEEE.....	10
6.3	FCC (USA).....	10
6.4	IC (CANADA).....	10
7	Mechanical characteristics .....	11
7.1	Nomad version.....	11
7.2	Fixed version .....	11
8	Ordering Information.....	12
9	Appendices .....	13
9.1	EU Declaration of Conformity (DoC) .....	13
9.2	Recycling .....	15
10	History.....	16

# 1 Introduction

## **Connect to system bus to monitor variables in the target system**

The TapNPass is designed for integration on a standard industrial bus that is already designed into the target system. The TapNPass supports physical connections on RS232, RS485 and USB (supporting FTDI232 and CP210x serial transceivers). Modules support Modbus and CANopen system protocols.

The TapNPass offers the following range of RF channels:

- NFC
- Bluetooth Smart "Low Energy"

## **Connecting TapNPass products to an embedded system**

The TapNPass connects to a system bus that has already been designed into the target embedded system. The IoTize co-processor included in all TapNPass modules manages the connection to the bus and the communication protocol (such as Modbus). Via the system bus, the module can non-intrusively read/write specific addresses or address ranges in the memory space associated with the bus.

## **Custom Designs**

TapNPass products can be designed or adapted to meet specific requirements for physical connection or protocol support for your system. Products can also be designed or adapted to meet the requirements of special use cases or use environments.

## 2 Summary

The TapNPass is an adapter that replaces a traditional wire connection – a cable - by a secure wireless link to a mobile device: smartphone or tablet running under Android, iOS or Win10. It supports the most popular serial connections such as RS-232, RS-485 and USB 2.0 (serial protocols).

---

### Radio Channels

- Near Field Communication (NFC) Type5 tag (ISO/IEC 15693)
- Bluetooth Low Energy (BLE) 4.1

### Serial link

- RS-232, RS-485 et USB (protocols CDC, FTDI et Silabs CP210x).
- Transparent mode or Modbus (master) service.

### Mobile platform

- HTML5 generic application
- API for Cordova (Android/Win10/iOS) or Android native (Java)

### Security features

- Configurable access profiles
- Configurable, encrypted passwords
- AES-128/256 module-level data encryption
- Configurable secure pairing with NFC

### Casing/versions

Two versions are available, with different plastic casing:

- Nomad with Li-Ion embedded batteries.
- Fix with a connector for external power supply.

### Electrical characteristics

- Input voltage (fix version): 8V to 30V
- Input voltage (nomad version): 5V (micro-USB connector)
- Battery capacity: 800mAh each (1600mAh total)
- Power consumption: from 10mA to 80mAH (depending on communication channel)
- Output current (USB host) up to 200mA

### Operating temperature range

- -10°C, +50°C

### Acceptance

- CE (Europe), FCC (USA), IC (Canada).
- REACH and RoHS compliant



### 3 Block schematic

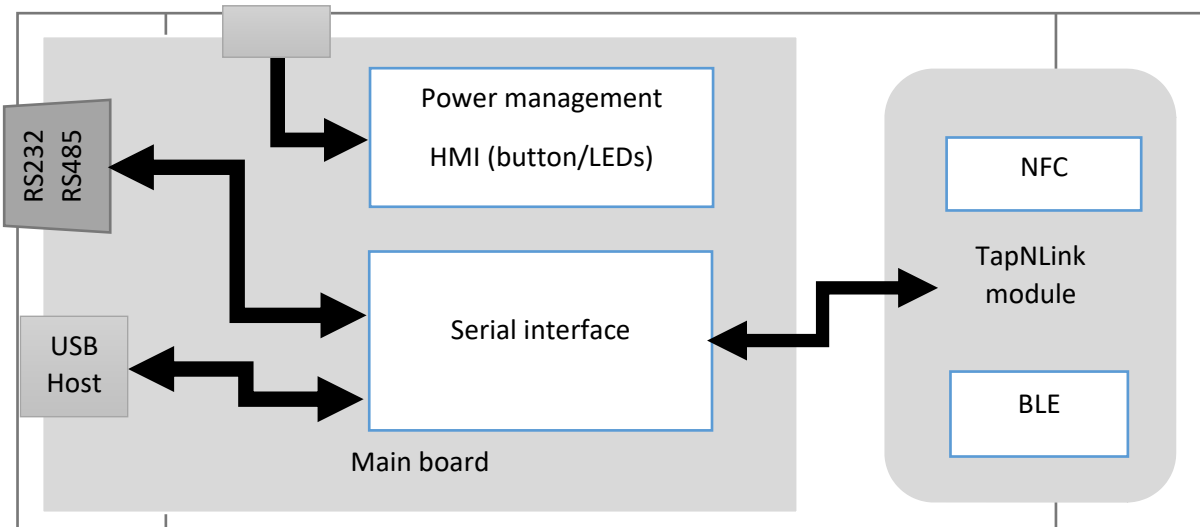

The TapNPass embeds a standard TapNLink module. This module manages radio communication, while serial communication is performed by the main board.

#### Serial modes

Two modes are available for serial communication:

- **Transparent mode:**  
TapNPass is used as a simple data transmission link (like a hardware cable). In this mode, the protocol must be supported by the target application. The API provides basic functions such as “SendByte” and “GetByte”.
- **Variable server mode:**  
TapNPass is used as a server for accessing data (variables) within a Modbus network. In this case, an access control list can be defined. The API provides high level functions such as “ReadVariable” or “Write variable”.

To test transparent mode, a simple “terminal application” (Toolbox) is provided.

To test variable server mode, IoTize Studio generates a simple HTML5 application.

The mode is selected by configuring the TapNLink module (see next chapter).

## 4 Development environment

### TapNLink module configuration

The TapNPass embeds a TapNLink radio module that requires configuration using IoTize Studio software that is freely available on the IoTize website.

IoTize Studio provides a simple and complete interface for managing the configuration of IoTize radio modules so that they interface correctly with the target system. IoTize Studio provides:

- Drag-and-drop configuration of target data addresses from the target's firmware source.
- Instant configuration transfer without extensive hardware installations
- Immediate configuration verification on the designers PC and smartphone

During TapNLink configuration, all variable information (address, type, etc.) is copied directly from the target's firmware source file, greatly reducing the risk of configuration errors. IoTize Studio allows users to transfer their configuration for testing and deployment with just the click of a button. No complicated or expensive hardware is required.

After configuration, the designer can connect to TapNPass and visualize the results in IoTize Studio's integrated app viewer, which shows the resulting user app exactly as it would display on a smartphone or other portable information appliances. When the designer is satisfied with the configuration, the result can be visualized on a portable appliance connected to the TapNLink via one of the supported radio interfaces.

IoTize Studio and TapNLink can transfer the designer's configuration to the target using a smartphone connection either directly with the designer's PC or via our Cloud-based MQTT relay. This implementation means that no additional hardware is required during the design phase.

## 5 Features

TapNPass offers plug'n play integration of contactless/wireless radio interfaces to connect a microcontroller-based target system to a local appliance (smartphones, PDAs, tablets, PCs, etc.).

TapNPass communicates with local appliances via their NFC and/or BLE interfaces. The IoTize Communication Service app (Android or iOS) on the local appliance manages its communication interfaces, thus eliminating the need for target-system designers to code or validate these mechanisms. Target-system designers can focus instead on creating the user interface for the target system.

With TapNPass NFC BLE modules, a local appliance can serve as a network gateway to send data to or retrieve data from the Cloud. Data that is read by TapNPass can be transmitted via the local appliance's data or network connection. For this, IoTize provides an MQTT-base relay with IoT Cloud platform translators. This MQTT infrastructure is open-source software that designers of target systems can install on servers and adapt to any private or public IoT Cloud platform.

### 5.1 Radio communication channels

#### 5.1.1 Near Field Communication (NFC)

- Data transmission rate<sup>1</sup>: 2 kilobytes per second
- Range<sup>2</sup>: to 4 centimeters
- Supports use of NFC for dynamic wakeup and pairing of the BLE interface.

#### 5.1.2 Bluetooth Low Energy (BLE)

- Max power: 4 dBm (approx. 2.5 mW)
- Data transmission rate<sup>1</sup>: 0.5 kilobytes per second
- Range<sup>2</sup>: to 30 meters

Notes:

1. Average speed while acquiring 1000 times 220 bytes from the target.
2. Measure line-of-site in an environment free of obstructions and rebound effects.

### 5.2 Serial communication channels

Three channels are available:

#### 5.2.1 RS232

- Baud rate: 300 kbps
- Minimum guaranteed slew rate: 6 V/ $\mu$ s
- Meets EIA/TIA 232 specifications.
- ESD Protection:
  - IEC61000-4-2 (Contact Discharge): +/-30kV
  - IEC61000-4-2 (Air Discharge): +/-30kV

#### 5.2.2 RS485

- Baud rate: up to 10 Mbps
- Receiver Input Hysteresis: 70mV
- ESD Protection +/- 15kV

#### 5.2.3 USB-Host

- USB 2.0 compliant
- Integrated Serial Driver CDC, FTDI (FT232x), Silabs (CP210x)

### 5.2.4 Communication cables

RS232 and RS485 are grouped onto a single RJ45 connector with a pinout compliant with the Modbus specification. TapNPass is delivered with three cables for data transmission (schematic available on the IoTize website):

- RJ45 to Sub D9 for RS232
- RJ45 to Sub D9 for RS485
- USB-A to USB-B

### 5.3 Security features

Customized firmware allows differentiated algorithms for each application. The communication chain is fully secured using classic techniques such as:

- Authentication: secured passwords or signed tokens
- Encryption: AES-128/256

### 5.4 Access control configuration

Access control data is stored in 2KB of E<sup>2</sup>PROM:

- Accessible data addresses: up to ~ 500
- User profiles: up to ~ 100
- Access rights: Read/Write
- Plus 3 predefined profiles of up to 96 characters.

### 5.5 Electrical characteristics

#### Power supply

- Maximum DC supply voltage 3.9V
- DC supply voltage 2.3V to 3.6V
- Low power consumption:
  - Standby: 80  $\mu$ A
  - NFC Tx/Rx: 7 mA
  - BLE Tx/Rx: 15 mA

When in standby mode, wake-up of the TapNPass is possible by NFC.

### 5.6 Batteries

Only the Nomad version is delivered with batteries:

- Two Li-Ion batteries: 3V7
- Total capacity: 800mAh each (1600mAh total)
- Dimensions: AA format 14500 with 51mm max for the length.

### 5.7 Radio specifications

#### 5.7.1 Near Field Communication (NFC)

- Data transmission rate<sup>1</sup>: 2 kilobytes per second
- Range<sup>2</sup>: up to 4 centimeters
- Supports use of NFC for dynamic wakeup and pairing the BLE interface.



### 5.7.2 Bluetooth Low Energy (BLE)

- Max power: 4 dBm (approx. 2.5 mW)
- Data transmission rate<sup>1</sup>: 0.5 kilobytes per second
- Range<sup>2</sup>: to 30 meters

Notes:

1. Average speed while acquiring 1000 times 220 bytes from the target.
  2. Measure line-of-site in an environment free of obstructions and rebound effects.
- Radio characteristics:

Parameter	Min	Typ	Max	Unit
Frequency range	2402	-	2480	MHz
Rx sensitivity		-93		dBm
Output power range	-20	3.0	3.0	dBm

### 5.8 Information appliance support

The IoTize TapManager app manages the radio interfaces on information appliances running Android v4.0.3 and iOS v10 or later versions.

### 5.9 Cloud support

TapNPass includes an open source MQTT relay. Designers using TapNPass are free to copy and adapt this to meet their specific requirements for data exchanges with IoT Cloud platforms. Full information about IoTize Cloud support for TapNPass is provided in the IoTize MQTT Relay User Manual.

### 5.10 Operating temperature range

The behavior and the radio characteristics have been tested to guarantee a correct operation in the range:

**[-20°C, +55°C]**

Important note:

When the temperature is below -10°C, the startup time ( $t_s$ ) of the BLE advertising increases. The following delay have been measured:

- For  $T > -10^\circ\text{C}$ ,  $t_s < 3$  s
- For  $T = -15^\circ\text{C}$ ,  $t_s = 20$  s
- For  $T = -20^\circ\text{C}$ ,  $t_s = 33$  s

This delay concerns only BLE, not NFC communication.

## 6 Regulatory compliance

### 6.1 Passed Tests

TapNPass has been tested also as a end product for the following standards:

- ETSI 301 489-1 (V2.1.1 + Draft V2.2.0)
- ETSI 301 489-17 (V3.1.1 + Draft V3.2.0)
- EN 62479 (2010)
- ETSI EN 300 328 (V2.1.1)
- ETSI EN 300 330 (V2.1.0)
- ETSI EN 300 440 (V2.1.1)
- EN 60950-1 (2006+A11/2009+A1/2010+A12/2011+A2/2013)
- CFR 47, FCC Part 15, Subpart C (Chapter 15.249 - Operation within the bands 902–928 MHz, 2400–2483.5 MHz, 5725–5875 MHz, and 24.0–24.25 GHz)
- Industry Canada, RSS-Gen Issue 5 (2018) & RSS-210 Issue 9 (2016), section B.10 (Bands 902–928, 2400–2483.5 and 5725–5875 MHz)
- EN 55032 (2015)
- EN 61000-6-2 (2006)
- EN 62311 (2008)

### 6.2 RoHS and WEEE

TapNPass complies with:

- Directive 2011/65/EU of the European Parliament and of the Council of 8 June 2011 on the restriction of the use of certain hazardous substances (ROHS) in electrical and electronic equipment.
- Directive 2012/19/EU of the European Parliament and of the Council of 4 July 2012 on waste electrical and electronic equipment (WEEE)

### 6.3 FCC (USA)

This product contains a transmitter module FCC ID: 2APCX-TNLFIR10.

To comply with FCC RF exposure compliance requirements, the antenna used for this transmitter must not be colocated or operating in conjunction with any other antenna or transmitter.

### 6.4 IC (CANADA)

This product contains a transmitter module IC: 23741-TNLFIR10.

*Ce produit contient un module transmetteur IC: 23741-TNLFIR10.*

## 7 Mechanical characteristics

The two versions differ in the upper part of the casing, and the size.

### 7.1 Nomad version

Dimensions: L 105mm x H 33mm x W 46mm

Weight (without cables): 110g



### 7.2 Fixed version

Dimensions: L 120mm x H 26mm x W 60mm

Weight (without cables): 100g

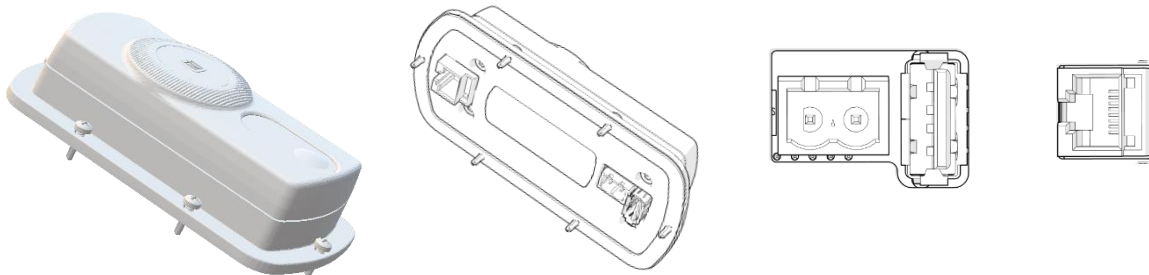

## 8 Ordering Information

Example part number: **TnP-NSR103**<sup>1</sup>

Product Line	Use Mode	Physical Interface	Radio Interface <sup>1</sup>	Product Prefix	Security
<b>TnP</b>	<b>N</b>	<b>S</b>	<b>R</b>	<b>10</b>	<b>3</b>

**Product Lines:**      **TnP = TapNPass**

**Use Mode:**            **F**    = Fixed (powered by target system)  
                               **N**    = **Nomad** (powered by embedded Li-Ion batteries)

**Physical interface:** **S**    = **Serial**

**Radio interface<sup>2</sup>:**    *T*<sup>3</sup> = *NFC Only*  
                               **R**    = **BLE**  
                               **W**    = Wi-Fi, BLE

**Security:**              **3**    = **software-based security**  
                                   *5*<sup>4</sup> = *hardware-based security with embedded secure element*

**Notes:**

1. The features of the part number shown in the table are indicated in bold.
2. All products include NFC by default for advanced functionalities such as secure wake-up and pairing.
3. These radio interfaces are not available for TapNPass.
4. Secure element management is not implemented on TapNPass.

## 9 Appendices

### 9.1 EU Declaration of Conformity (DoC)

EU Declaration of Conformity (DoC)



---

**We, the undersigned:** **IoTize S.A.S.**  
 960, chemin de la Croix Verte  
 38330 Montbonnot St Martin, France  
 Email: [contact@iotize.com](mailto:contact@iotize.com)  
 Phone: +33 4 76 41 87 99

**Designated product:** **TapNPASS Serial to Bluetooth Low Energy converter- TnPxxR103**

Included electronic board product  
 Model: TnLFIR103  
 Frequency band 1: 2400-2483.5MHz  
 Max Power: 10mW (e.i.r.p)

**Certify and declare:** **under our sole responsibility that the designated product is in conformity with the essential requirements and provisions of the following European Directives:**

Directive 2014/53/EU of the European Parliament and of the Council of 16 April 2014 on the harmonisation of the laws of the Member States relating to the making available on the market of radio equipment (RED).  
*The conformity of the designated product(s) with the provisions of this European Directive is given by the compliance with the following European Standard(s):*

<i>Article 3.1a concerning the requirements relative to health and safety protection of people and animals, and the protection of property with reference to 2014/53/EU directive.</i>	- EN 60950-1 (2006+A11/2009+A1/2010+A12/2011+A2/2013) - EN 62479 (2010)
<i>Article 3.1b concerning the requirements relative to protection with respect to Electromagnetic compatibility, with reference to 2014/30/EU directive.</i>	- ETSI 301 489-1 (V2.1.1 + Draft V2.2.0) - ETSI 301 489-17 (V3.1.1 + Draft V3.2.0) - EN 61000-6-2 (2006) - EN 55032 (2015)
<i>Article 3.2 concerning the requirements relative to proper use of the radio frequency spectrum.</i>	- ETSI EN 300 328 (V2.1.1) - ETSI EN 300 330 (V2.1.0) - ETSI EN 300 440 (V2.1.1) - EN 62311 (2008)

Directive 2011/65/EU of the European Parliament and of the Council of 8 June 2011 on the restriction of the use of certain hazardous substances (ROHS) in electrical and electronic equipment.

Directive 2012/19/EU of the European Parliament and of the Council of 4 July 2012 on waste electrical and electronic equipment (WEEE).



iotize.com

TapNPASS DoC, page 1 of 2

## EU Declaration of Conformity (DoC)



<b>Important Notice:</b>	Red approval is only valid for products in delivery state, including standard hardware and software. The user is responsible for operating the radio equipment and the accessories as intended and in accordance with the provided instructions. It is the responsibility of the OEM manufacturer to demonstrate compliance with all applicable EU directives and standards. The IoTize declaration of conformity serves as a support input for the declaration of conformity for the final equipment.
--------------------------	--

**The technical construction file is available from:**

IoTize S.A.S  
960 chemin de la Croix Verte  
38330 Montbonnot Saint Martin  
FRANCE  
Phone: +33 4 76 41 87 99

*Issued on November 14<sup>th</sup>, 2018.*



**Name and position of person binding the manufacturer or his authorized representative:**

Name: Francis Lamotte  
Position: President  
Email: [francis.lamotte@iotize.com](mailto:francis.lamotte@iotize.com)

Signature:



## 9.2 Recycling

 	This symbol of the crossed out wheeled bin indicates that the product (electrical and electronic equipment) should not be placed in municipal waste. Check local regulation for disposal of electronic products.
	<b>DO NOT</b> throw the battery in <u>municipal waste</u> . The symbol of the crossed out wheeled bin indicates that the batteries should not be placed in municipal waste.

## 10 History

Date	Version	Author	Modification
Oct. 2018	1.0	SG	First release version.
Dec. 2018	1.2	FL/JH	Update 'recycling' paragraph.
Jan. 2023	1.3	ES	Fix some naming errors. Update ordering information with new protocols. Rename the file. Update Serial Communication Channel. Update Summary.





### **Disclaimer**

Information in this document is subject to change without notice and does not represent a commitment on the part of the author(s).

No part of this document may be reproduced or transmitted in any form or by any means, electronic or mechanical, including photocopying, recording, or information storage and retrieval systems, for any purpose other than the development of the IoTize™ technology, without prior written permission from IoTize SAS and the IoTize™ consortium members.

Every effort has been made to ensure the accuracy of this manual and to give appropriate credit to persons, companies and trademarks referenced herein.

This document exists in electronic form (pdf) only.

### **Copyright © IoTize All rights reserved**

*IoTize™ is a registered trademark of IoTize SAS. All other registered names and trademarks are the property of their respective owners.*